

# AAT3221/AAT3222: 150 mA Nanopower™ LDO Linear Regulator

## Applications

- Cellular phones
- Digital cameras
- Handheld electronics
- Notebook computers
- PDAs
- Portable communication devices
- Remote controls

## Features

- Quiescent current: 1.1  $\mu$ A
- Low dropout: 200 mV (typical)
- Guaranteed output: 150 mA
- High accuracy:  $\pm 2\%$
- Current limit protection
- Over-temperature protection
- Extremely low power shutdown mode
- Low temperature coefficient
- Factory-programmed output voltages: 1.5 V to 3.5 V
- Stable operation with virtually any output capacitor type
- Active high or low enable pin
- Small, 5-pin SOT23 or 8-pin SC70JW (AAT3221 only) package (MSL1, 260 °C per JEDEC-J-STD-020)

## Description

The AAT3221 and AAT3222 NanoPower™ Low Drop Out (LDO) linear regulators are ideal for portable applications where extended battery life is critical. These devices feature extremely low quiescent current, typically 1.1  $\mu$ A. Dropout voltage is also very low, typically less than 200 mV at the maximum output current of 150 mA. The AAT3221/3222 have an enable pin which, when asserted, places the LDO regulator into shutdown mode, removing power from its load and offering extended power conservation capabilities for portable battery-powered applications.

The AAT3221/3222 have output short-circuit and over-current protection. In addition, the devices also have an over-temperature protection circuit that shuts down the LDO regulator during extended over-current events. Both devices are available with active high or active low enable input.

The AAT3221 and AAT3222 are available in Pb-free, space-saving 5-pin SOT23 packages. The AAT3221 is also available in a Pb-free, 8-pin SC70JW package. Since only a small, 1  $\mu$ F ceramic output capacitor is recommended, often the only space used is that occupied by the AAT3221 or AAT3222. The AAT3221/3222 provide a compact and cost-effective voltage conversion solution.

Both devices are similar to the AAT3220, with the exception that they offer further power savings with an enable pin.

A typical application circuit is shown in Figure 1. The pin configuration is shown in Figures 2, 3, and 4. Signal pin assignments and functional pin descriptions are provided in Table 1.



Skyworks Green™ products are compliant with all applicable legislation and are halogen-free. For additional information, refer to *Skyworks Definition of Green™*, document number SQ04-0074.

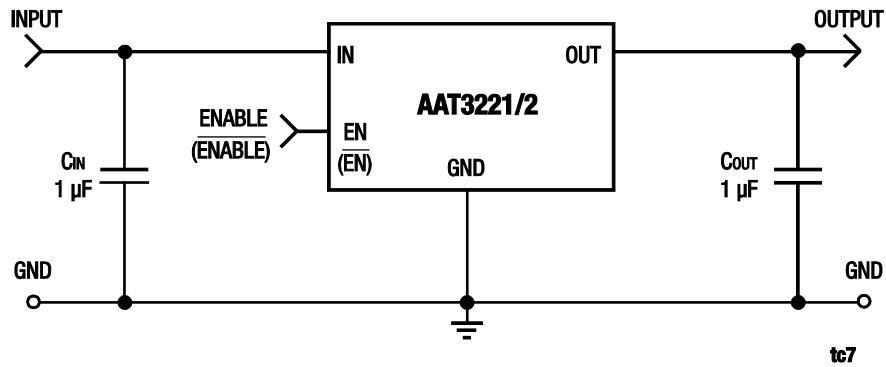

Figure 1. AAT3221/3222 Typical Application Circuit

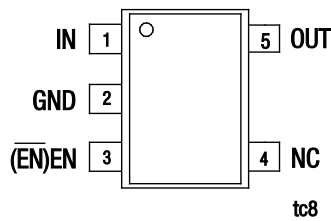

Figure 2. AAT3221 Pinout 5-Pin SOT23-5 (Top View)

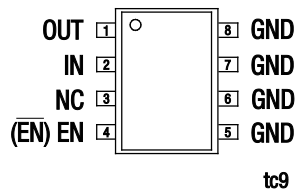

Figure 3. AAT3221 Pinout 8-Pin SC70JW-8 (Top View)

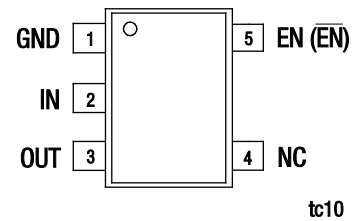

Figure 4. AAT3222 Pinout 5-Pin SOT23-5 (Top View)

Table 1. AAT3221/3222 Signal Descriptions

Pin #		AAT3222	Name	Description
AAT3221				
SOT23-5	SC70JW-8			
1	2	2	IN	Input pin.
2	5, 6, 7, 8	1	GND	Ground connection pin.
3	4	5	EN(EN)	Enable input. Logic compatible enable with active high or active low option available; see Ordering Information and Applications Information for details.
4	3	4	NC	Not connected.
5	1	3	OUT	Output pin; should be decoupled with 1 μF or greater capacitor.

## Electrical and Mechanical Specifications

The absolute maximum ratings of the AAT3221/3222 are provided in Table 2.

The recommended operating conditions are specified in Table 3, and electrical specifications are provided in Table 4.

Typical performance characteristics of the AAT3221/3222 are illustrated in Figures 5 through 22.

**Table 2. AAT3221/3222 Absolute Maximum Ratings (Note 1)**

Parameter	Symbol	Minimum	Typical	Maximum	Units
Input Voltage, <30 ms, 10% DC (continuous max. = 6.0 V)	V <sub>IN</sub>	-0.3		+7	V
EN( $\overline{\text{EN}}$ ) to GND Voltage	V <sub>EN</sub>	-0.3		+6	V
Maximum EN( $\overline{\text{EN}}$ ) to Input Voltage	V <sub>ENIN(MAX)</sub>		0.3		V
Maximum DC Output Current	I <sub>OUT</sub>		P <sub>D</sub> /(V <sub>IN</sub> - V <sub>O</sub> )		mA
Operating Junction Temperature Range	T <sub>J</sub>	-40		+150	°C
Thermal Resistance (Note 2)	θ <sub>JA</sub>	SOT23-5		150	°C/W
		SC70JW-8		160	°C/W
Power Dissipation (Note 2)	P <sub>D</sub>	SOT23-5		667	mW
		SC70JW-8		625	mW
Electrostatic Discharge: Human Body Model, Class 3A	ESD			4000	V

**Note 1:** Exposure to maximum rating conditions for extended periods may reduce device reliability. There is no damage to device with only one parameter set at the limit and all other parameters set at or below their nominal value. Exceeding any of the limits listed may result in permanent damage to the device.

**Note 2:** Support I<sub>N</sub> high voltage pulse up to 7 V lasting 8 μs.

**CAUTION:** Although this device is designed to be as robust as possible, Electrostatic Discharge (ESD) can damage this device. This device must be protected at all times from ESD. Static charges may easily produce potentials of several kilovolts on the human body or equipment, which can discharge without detection. Industry-standard ESD precautions should be used at all times.

**Table 3. AAT3221/3222 Recommended Operating Conditions**

Parameter	Symbol	Minimum	Typical	Maximum	Units
Input voltage (Note 1)	V <sub>IN</sub>	(V <sub>OUT</sub> + V <sub>DO</sub> )		5.5	V
Ambient temperature range	T <sub>A</sub>	-40		+85	°C

**Note 1:** To calculate minimum input voltage, use the following equation: V<sub>IN(MIN)</sub> = V<sub>OUT(MAX)</sub> + V<sub>DO(MAX)</sub> as long as V<sub>IN</sub> ≥ 2.5 V.

**Table 4. AAT3221/3222 Electrical Specifications (1 of 2) (Note 1)**  
**(VIN = Vout(NOM) + 1 V, IOUT = 1 mA, COUT = 1 μF, TA = 25 °C, Unless Otherwise Noted)**

Parameter	Symbol	Test Condition	Min	Typical	Max	Units	
DC output voltage tolerance	VOUT		-2.0		+2.0	%	
Output current	IOUT	VOUT > 1.2 V	150			mA	
Short-circuit current	ISC	VOUT < 0.4 V		350		mA	
Ground current	Iq	VIN = 5 V, no load		1.1	2.5	μA	
Shutdown current	ISD	EN = inactive		20		nA	
Line regulation	$\Delta V_{out}/V_{out} \times \Delta V_{in}$	VIN = 4.0 V to 5.5 V		0.15	0.4	%/V	
Load regulation	$\Delta V_{out}/V_{out}$	IOUT = 1 to 100 mA	VOUT = 1.5		1.3	1.72	%
			VOUT = 1.6		1.2	1.69	
			VOUT = 1.7		1.1	1.67	
			VOUT = 1.8		1.0	1.65	
			VOUT = 1.9		1.0	1.62	
			VOUT = 2.0		0.9	1.58	
			VOUT = 2.3		0.8	1.45	
			VOUT = 2.4		0.8	1.40	
			VOUT = 2.5		0.8	1.35	
			VOUT = 2.6		0.8	1.30	
			VOUT = 2.7		0.7	1.25	
			VOUT = 2.8		0.7	1.20	
			VOUT = 2.85		0.7	1.20	
			VOUT = 2.9		0.7	1.18	
			VOUT = 3.0		0.6	1.15	
VOUT = 3.1		0.6	1.06				
VOUT = 3.3		0.5	1.00				
VOUT = 3.5		0.5	1.00				
Dropout voltage (Note 2, 3)	VDO	IOUT = 100 mA	VOUT = 2.3		230	275	mV
			VOUT = 2.4		220	265	
			VOUT = 2.5		210	255	
			VOUT = 2.6		205	247	
			VOUT = 2.7		200	240	
			VOUT = 2.8		190	235	
			VOUT = 2.85		190	230	
			VOUT = 2.9		190	228	
			VOUT = 3.0		190	225	
			VOUT = 3.1		188	222	
			VOUT = 3.3		180	220	
			VOUT = 3.5		180	220	

**Table 4. AAT3221/3222 Electrical Specifications (2 of 2) (Note 1)**  
**( $V_{IN} = V_{OUT(NOM)} + 1\text{ V}$ ,  $I_{OUT} = 1\text{ mA}$ ,  $C_{OUT} = 1\text{ }\mu\text{F}$ ,  $T_A = 25\text{ }^\circ\text{C}$ , Unless Otherwise Noted)**

Parameter	Symbol	Test Condition	Min	Typical	Max	Units
EN Input low voltage	$V_{EN(L)}$				0.8	V
EN Input high voltage	$V_{EN(H)}$	$V_{IN} = 2.7\text{ V to }3.6\text{ V}$	2.0			V
		$V_{IN} = 5\text{ V}$	2.4			
EN Input leakage	$I_{EN(SINK)}$	$V_{ON} = 5.5\text{ V}$		0.01	1	$\mu\text{A}$
Power supply rejection ratio	PSRR	@ 100 Hz		50		dB
Over-temperature shutdown threshold	TSD			140		$^\circ\text{C}$
Over-temperature shutdown hysteresis	THYS			20		$^\circ\text{C}$
Output noise	eN	$f = 10\text{ Hz to }10\text{ kHz}$		350		$\mu\text{VRMS}$
Output voltage temperature coefficient	Tc			80		PPM/ $^\circ\text{C}$

**Note 1:** Performance is guaranteed only under the conditions listed in this Table.

**Note 2:**  $V_{DO}$  is defined as  $V_{IN} - V_{OUT}$  when  $V_{OUT}$  is 98% of nominal.

**Note 3:** For  $V_{OUT} < 2.3\text{ V}$ ,  $V_{DO} = 2.5\text{ V} - V_{OUT}$ .

### Typical Performance Characteristics

( $V_{IN} = V_{OUT} + 1\text{ V}$ ,  $T_A = 25\text{ }^\circ\text{C}$ ,  $C_{OUT} = 5.6\text{ }\mu\text{F}$  Ceramic,  $I_{OUT} = 1\text{ mA}$ , Unless Otherwise Noted)

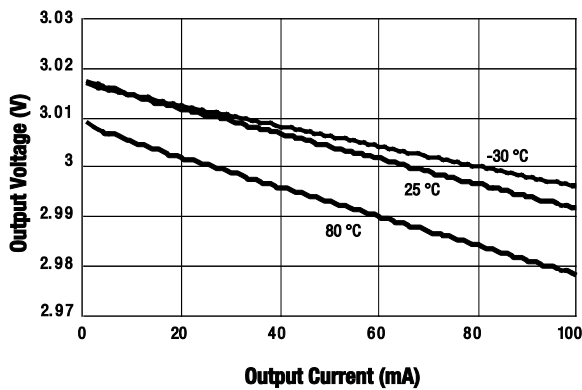

Figure 5. Output Voltage vs Output Current

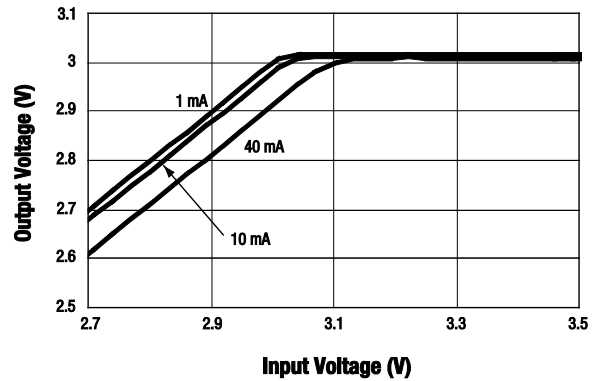

Figure 6. Output Voltage vs Input Voltage

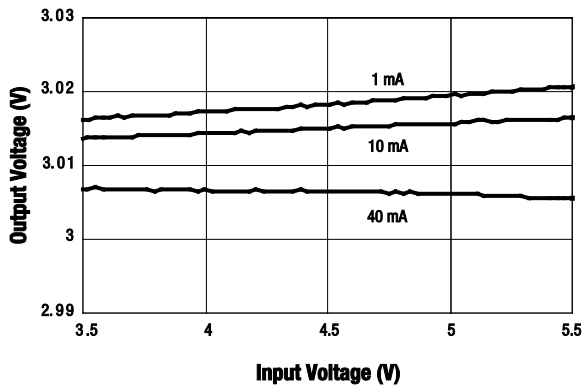

Figure 7. Output Voltage vs Input Voltage

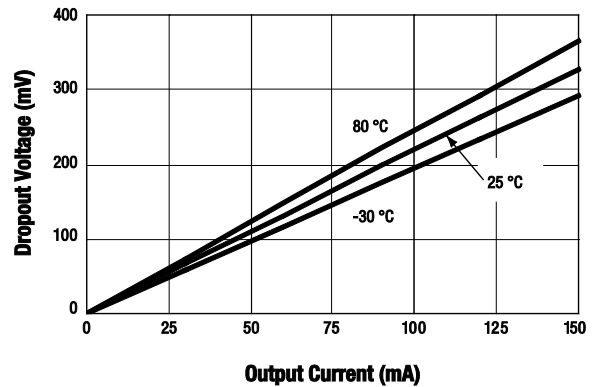

Figure 8. Dropout Voltage vs Output Current

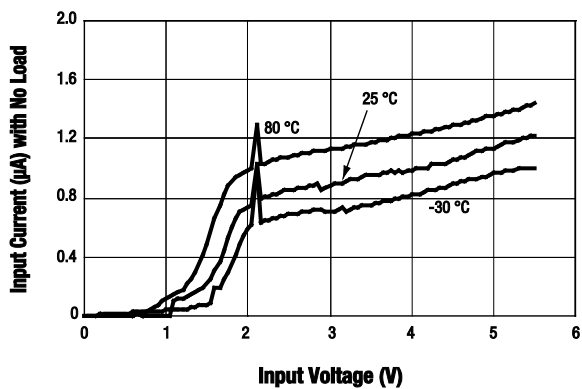

Figure 9. Supply Current vs Input Voltage

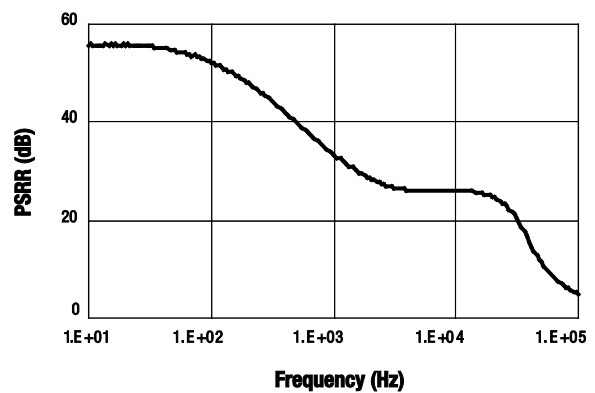

Figure 10. PSRR with 10 mA Load

## Typical Performance Characteristics

( $V_{IN} = V_{OUT} + 1\text{ V}$ ,  $T_A = 25\text{ }^\circ\text{C}$ ,  $C_{OUT} = 5.6\text{ }\mu\text{F}$  Ceramic,  $I_{OUT} = 1\text{ mA}$ , Unless Otherwise Noted)

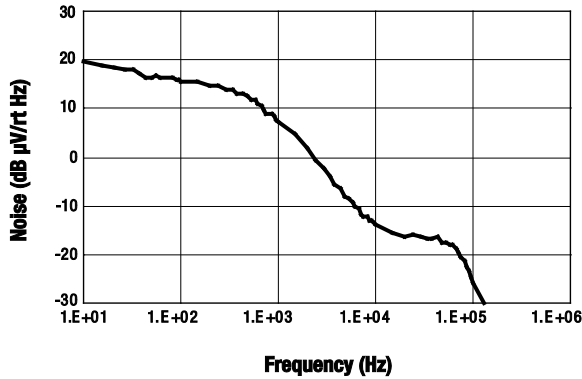

Figure 11. Noise Spectrum

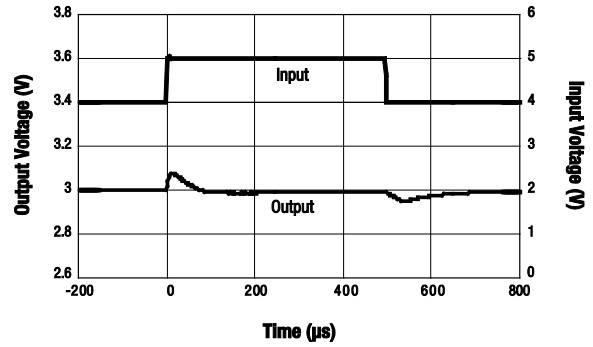

Figure 12. Line Response with 1 mA Load

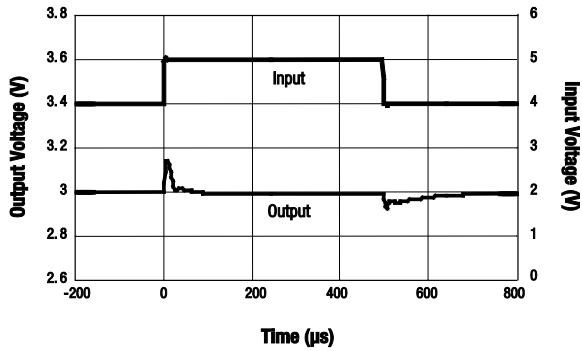

Figure 13. Line Response with 10 mA Load

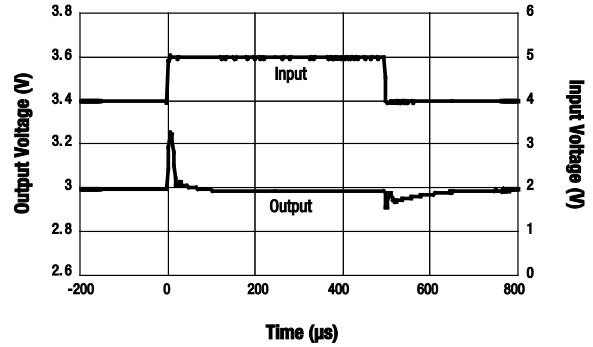

Figure 14. Line Response with 100 mA Load

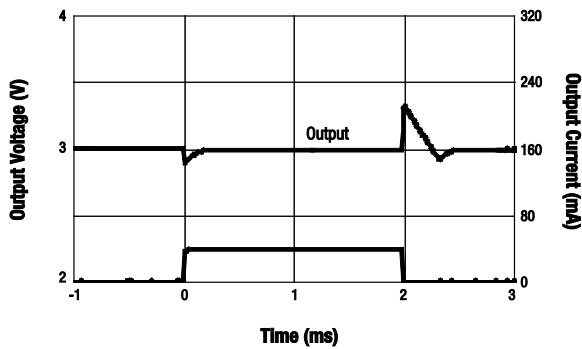

Figure 15. Load Transient – 1 mA/40 mA

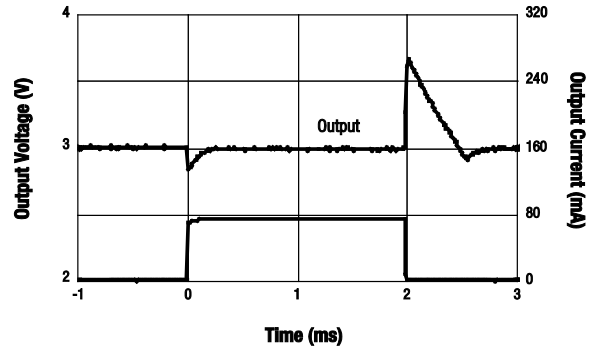

Figure 16. Load Transient – 1 mA/80 mA

## Typical Performance Characteristics

( $V_{IN} = V_{OUT} + 1\text{ V}$ ,  $T_A = 25\text{ }^\circ\text{C}$ ,  $C_{OUT} = 5.6\text{ }\mu\text{F}$  Ceramic,  $I_{OUT} = 1\text{ mA}$ , Unless Otherwise Noted)

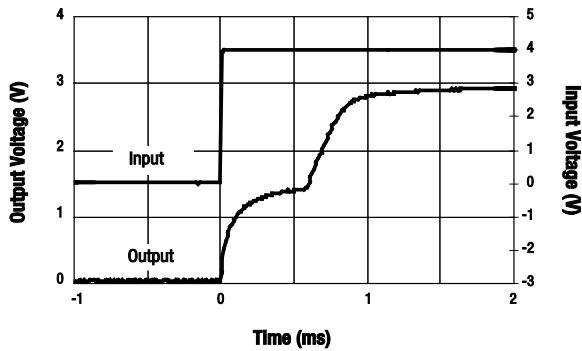

Figure 17. Power-Up with 1 mA Load

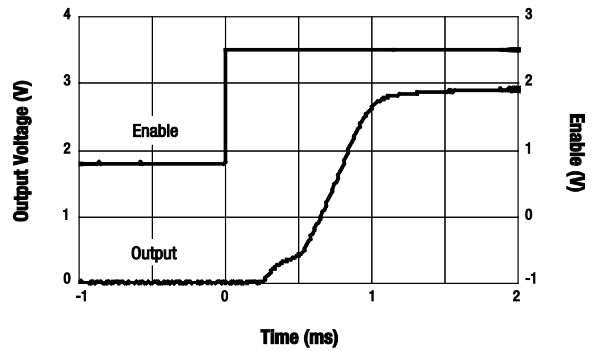

Figure 18. Turn-On with 1 mA Load

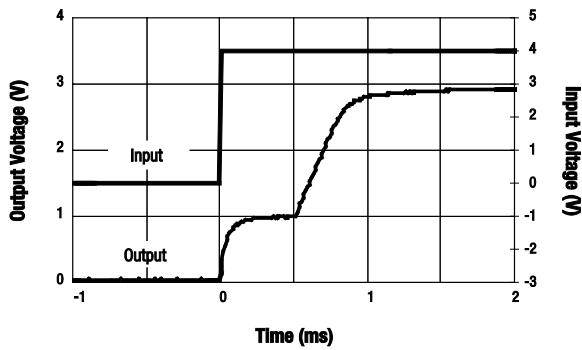

Figure 19. Power-Up with 10 mA Load

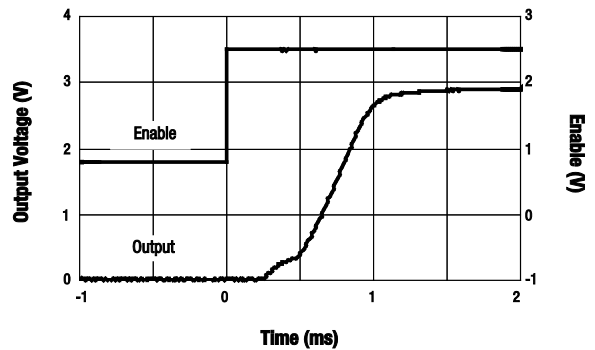

Figure 20. Turn-On with 10 mA Load

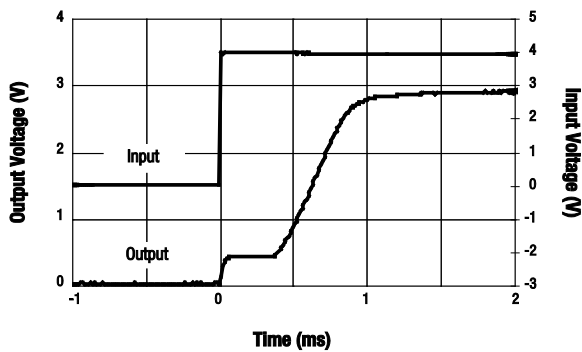

Figure 21. Power-Up with 100 mA Load

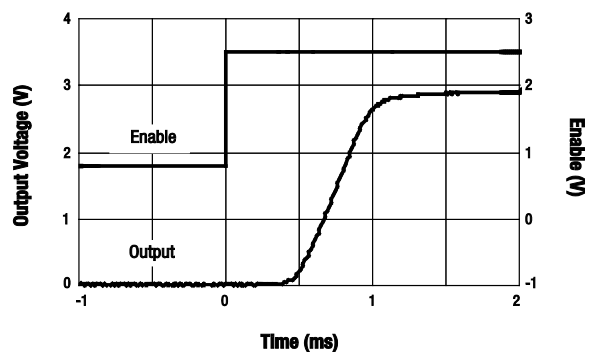
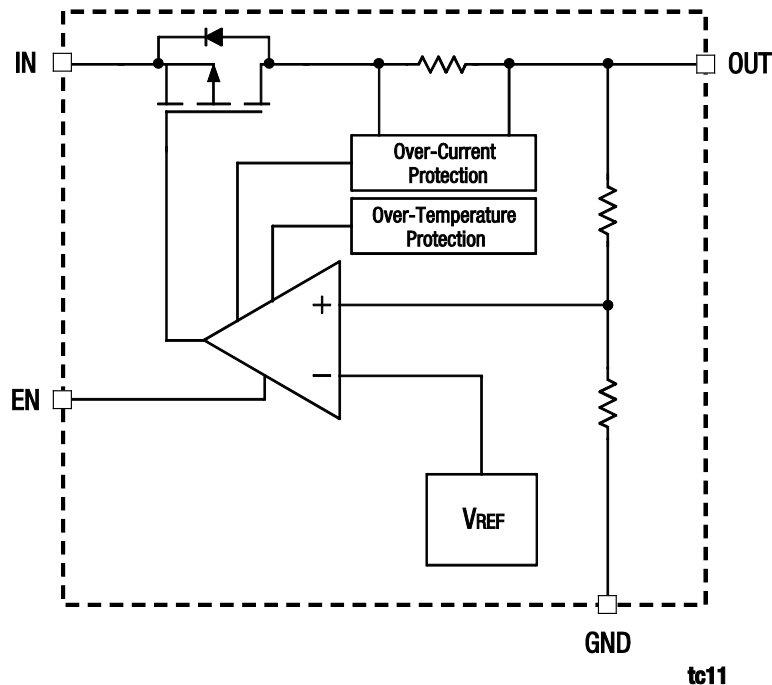

Figure 22. Turn-On with 100 mA Load





**Figure 23. AAT3221/3222 Functional Block Diagram**

## Functional Description

The AAT3221 and AAT3222 are intended for LDO regulator applications where output current load requirements range from no load to 150 mA. The advanced circuit design of the AAT3221/3222 has been optimized for very low quiescent or ground current consumption, making these devices ideal for use in power management systems for small battery-operated devices.

The typical quiescent current level is just 1.1  $\mu\text{A}$ . Both devices also contain an enable circuit that has been provided to shut down the LDO regulator for additional power conservation in portable products. In the shutdown state, the LDO draws less than 1  $\mu\text{A}$  from the input supply.

The LDO also demonstrates excellent Power Supply Ripple Rejection (PSRR), and load and line transient response characteristics. The AAT3221/3222 high performance LDO regulators are especially well suited for circuit applications that are sensitive to load circuit power consumption and extended battery life.

The LDO regulator output has been specifically optimized to function with low-cost, low Equivalent Series Resistance (ESR) ceramic capacitors. However, the design allows for operation with a wide range of capacitor types.

The AAT3221/3222 have complete short-circuit and thermal protection. The integral combination of these two internal protection circuits gives each device a comprehensive safety system to guard against extreme adverse operating conditions. Device power dissipation is limited to the package type and

thermal dissipation properties. Refer to the Thermal Considerations and High Output Current Applications section of this document for details on device operation at maximum output load levels.

## Application Information

To ensure that the maximum possible performance is obtained from the AAT3221 or AAT3222, please refer to the following application recommendations.

### Input Capacitor

A 1  $\mu\text{F}$  or larger capacitor is typically recommended for  $C_{\text{IN}}$  in most applications. A  $C_{\text{IN}}$  capacitor is not required for basic LDO regulator operation. However, if the AAT3221/3222 are physically located more than one or two centimeters from the input power source, a  $C_{\text{IN}}$  capacitor is needed for stable operation.  $C_{\text{IN}}$  should be located as closely to the device  $V_{\text{IN}}$  pin as practically possible.  $C_{\text{IN}}$  values greater than 1  $\mu\text{F}$  offer superior input line transient response and helps to maximize the power supply ripple rejection.

Ceramic, tantalum, or aluminum electrolytic capacitors may be selected for  $C_{\text{IN}}$ , as there is no specific capacitor ESR requirement. For 150 mA LDO regulator output operation, ceramic capacitors are recommended for  $C_{\text{IN}}$  due to their inherent capability over tantalum capacitors to withstand input current surges from low impedance sources such as batteries in portable devices.

## Output Capacitor

For proper load voltage regulation and operational stability, a capacitor is required between pins V<sub>OUT</sub> and GND. The C<sub>OUT</sub> capacitor connection to the LDO regulator ground pin should be made as direct as practically possible for maximum device performance.

The AAT3221/3222 have been specifically designed to function with very low ESR ceramic capacitors. Although the devices are intended to operate with these low ESR capacitors, they are stable over a wide range of capacitor ESRs. Therefore, they can also work with some higher ESR tantalum or aluminum electrolytic capacitors. However, for best performance, ceramic capacitors are recommended.

The value of C<sub>OUT</sub> typically ranges from 0.47 μF to 10 μF; however, 1 μF is sufficient for most operating conditions.

If large output current steps are required by an application, then an increased value for C<sub>OUT</sub> should be considered. The amount of capacitance needed can be calculated from the step size of the change in output load current expected and the voltage excursion that the load can tolerate.

The total output capacitance required can be calculated using the following formula:

$$C_{OUT} = \frac{\Delta I}{\Delta V} \times 15 \mu F$$

Where:

ΔI = maximum step of output current

ΔV = maximum excursion voltage that the load can tolerate

Note that use of this equation results in capacitor values approximately two to four times the typical value needed for an AAT3221 or AAT3222 at room temperature. The increased capacitor value is recommended if tight output tolerances must be maintained over extreme operating conditions and maximum operational temperature excursions. If tantalum or aluminum electrolytic capacitors are used, the capacitor value should be increased to compensate for the substantial ESR inherent to these capacitor types.

## Capacitor Characteristics

Ceramic composition capacitors are highly recommended over all other types of capacitors for use with the AAT3221/3222.

Ceramic capacitors offer many advantages over their tantalum and aluminum electrolytic counterparts. A ceramic capacitor typically has a very low ESR, a lower cost, a smaller PCB footprint, and is non-polarized. Line and load transient response of the LDO regulator is improved by using low-ESR ceramic capacitors. Since ceramic capacitors are non-polarized, they are less prone to damage if incorrectly connected.

## Equivalent Series Resistance (ESR)

ESR is a very important characteristic to consider when selecting a capacitor. ESR is the internal series resistance associated with a capacitor, which includes lead resistance, internal connections, capacitor size and area, material composition, and ambient temperature. Typically, capacitor ESR is measured in milliohms for ceramic capacitors and can range to more than several Ohms for tantalum or aluminum electrolytic capacitors.

## Ceramic Capacitor Materials

Ceramic capacitors less than 0.1 μF are typically made from NPO or COG materials. NPO and COG materials have a typically tight tolerance and are very stable over temperature ranges. Larger capacitor values are typically composed of X7R, X5R, Z5U, and Y5V dielectric materials. Large ceramic capacitors, typically greater than 2.2 μF, are often available in low-cost Y5V and Z5U dielectrics. These two material types are not recommended for use with LDO regulators since the capacitor tolerance can vary more than ±50% over the operating temperature range of the device.

A 2.2 μF, Y5V capacitor could be reduced to 1 μF over the full operating temperature range. This can cause problems for circuit operation and stability. X7R and X5R dielectrics are much more desirable. The temperature tolerance of X7R dielectric is better than ±15%.

Capacitor area is another contributor to ESR. Capacitors that are physically large in size have a lower ESR when compared to a smaller sized capacitor of equivalent material and capacitance value. These larger devices can also improve circuit transient response when compared to an equal value capacitor in a smaller package size.

Consult capacitor vendor Data Sheets carefully when selecting capacitors for use with LDO regulators.

## Enable Function

The AAT3221/3222 devices feature an LDO regulator enable/disable function. This pin (EN) is compatible with CMOS logic. Active high or active low options are available (see Ordering Information).

For a logic high signal, the EN control level must be greater than 2.4 V. A logic low signal is asserted when the voltage on the EN pin falls below 0.8 V. For example, the active high versions of the AAT3221 and AAT3222 turns on when a logic high is applied to the EN pin. If the enable function is not needed in a specific application, it may be tied to the respective voltage level to keep the LDO regulator in a continuously “on” state (e.g., the active high version AAT3221/3222 can tie V<sub>IN</sub> to EN to remain on).

### Short-Circuit Protection and Thermal Protection

The AAT3221/2 is protected by both current limit and over-temperature protection circuitry. The internal short-circuit current limit is designed to activate when the output load demand exceeds the maximum rated output.

If a short-circuit condition was to continually draw more than the current limit threshold, the LDO regulator output voltage drops to a level necessary to supply the current demanded by the load. Under short-circuit or other over-current operating conditions, the output voltage drops and the device die temperature rapidly increases.

Once the regulator's power dissipation capacity is exceeded and the internal die temperature reaches approximately 140 °C, the system thermal protection circuit becomes active. The internal thermal protection circuit actively turns off the LDO regulator output pass device to prevent the possibility of over-temperature damage. The LDO regulator output remains in a shutdown state until the internal die temperature falls back below the 140 °C trip point.

The interaction between the short-circuit and thermal protection systems allows the LDO regulator to withstand indefinite short-circuit conditions without sustaining permanent damage.

### No-Load Stability

The AAT3221 and AAT3222 are designed to maintain output voltage regulation and stability under operational no-load conditions. This is an important characteristic for applications where the output current may drop to zero.

An output capacitor is required for stability under no-load operating conditions. Refer to the Output Capacitor section of this document for recommended typical output capacitor values.

### Thermal Considerations and High Output Current Applications

The AAT3221/3222 are designed to deliver a continuous output load current of 150 mA under normal operating conditions. The limiting characteristic for the maximum output load safe operating area is essentially package power dissipation and the internal preset thermal limit of the device.

To obtain high operating currents, careful device layout and circuit operating conditions need to be taken into account. The following discussion assumes that the LDO regulator is mounted on a printed circuit board using the minimum recommended footprint, and the printed circuit board is 0.062-inch thick FR4 material with one ounce copper.

At any given ambient temperature ( $T_A$ ), the maximum package power dissipation can be determined by the following equation:

$$P_{D(MAX)} = \frac{T_{J(MAX)} - T_A}{\theta_{JA}}$$

Constants for the AAT3221/3222 are  $T_{J(MAX)}$ , the maximum junction temperature for the device, which is 125 °C, and  $Q_{JA} = 150$  °C/W, the package thermal resistance. Typically, the maximum package power is calculated at the maximum operating temperature where  $T_A = 85$  °C, and under normal ambient conditions  $T_A = 25$  °C. Given  $T_A = 85$  °C, the maximum package power dissipation is 267 mW. At  $T_A = 25$  °C, the maximum package power dissipation is 667 mW.

The maximum continuous output current for the AAT3221/3222 is a function of the package power dissipation and the input-to-output voltage drop across the LDO regulator. Refer to the following simple equation:

$$I_{OUT(MAX)} = \frac{P_{D(MAX)}}{(V_{IN} - V_{OUT})}$$

For example, if  $V_{IN} = 5$  V,  $V_{OUT} = 2.5$  V and  $T_A = 25$  °C,  $I_{OUT(MAX)} < 267$  mA. The output short-circuit protection threshold is set between 150 mA and 300 mA. If the output load current were to exceed 267 mA or if the ambient temperature were to increase, the internal die temperature would increase. If the condition remained constant and the short-circuit protection did not activate, there would be a potential damage hazard to the LDO regulator since the thermal protection circuit would only activate after a short-circuit event occurred on the LDO regulator output.

To determine the maximum input voltage for a given load current, refer to the following equation. This calculation accounts for the total power dissipation of the LDO regulator, including that caused by ground current.

$$P_{D(MAX)} = (V_{IN} - V_{OUT}) \times I_{OUT} + (V_{IN} \times I_{GND})$$

This formula can be solved for  $V_{IN}$  to determine the maximum input voltage.

$$V_{IN(MAX)} = \frac{P_{D(MAX)} + (V_{OUT} \times I_{OUT})}{I_{OUT} + I_{GND}}$$

The following is an example of the AAT3221 or AAT3222 set for a 2.5 V output:

$V_{OUT} = 2.5$  V  
 $I_{OUT} = 150$  mA  
 $I_{GND} = 1.1$   $\mu$ A

$$\begin{aligned} V_{IN(MAX)} &= \frac{667 \text{ mW} + (2.5 \text{ V} \times 150 \text{ mA})}{150 \text{ mA} + 1.1 \text{ } \mu\text{A}} \\ &= 6.95 \text{ V} \end{aligned}$$

From the discussion above,  $P_{D(MAX)}$  was determined to equal 667 mW at  $T_A = 25$  °C. Therefore, the AAT3221/3222 can sustain a constant 2.5 V output at a 150 mA load current as long as  $V_{IN} \leq 6.95$  V at an ambient temperature of 25 °C. The maximum input operating voltage is 5.5 V for the AAT3221/3222. Therefore, at 25 °C, the device would not have any thermal concerns or operational  $V_{IN(MAX)}$  limits.

This situation can be different at 85 °C. The following is an example for an AAT3221/3222 set for a 2.5 V output at 85 °C:

V<sub>OUT</sub> = 2.5 V  
 I<sub>OUT</sub> = 150 mA  
 I<sub>GND</sub> = 1.1 μA

$$V_{IN(MAX)} = \frac{267 \text{ mW} + (2.5 \text{ V} \times 150 \text{ mA})}{(150 \text{ mA} + 1.1 \text{ } \mu\text{A})}$$

$$V_{IN(MAX)} = 4.28 \text{ V}$$

From the discussion above, P<sub>D(MAX)</sub> was determined to equal 267 mW at T<sub>A</sub> = 85 °C.

Higher input-to-output voltage differentials can be obtained with the AAT3221/3222, while maintaining device functions in the thermal safe operating area. To accomplish this, the device thermal resistance must be reduced by increasing the heat sink area or by operating the LDO regulator in a duty-cycled mode.

For example, an application requires V<sub>IN</sub> = 5.0 V while V<sub>OUT</sub> = 2.5 V at a 150 mA load and T<sub>A</sub> = 85 °C. V<sub>IN</sub> is greater than 4.28 V, which is the maximum safe continuous input level for V<sub>OUT</sub> = 2.5 V at 150 mA for T<sub>A</sub> = 85 °C. To maintain this high input voltage and output current level, the LDO regulator must be operated in a duty-cycled mode. Refer to the following calculation for duty-cycle operation:

I<sub>GND</sub> = 1.1 μA  
 I<sub>OUT</sub> = 150 mA  
 V<sub>IN</sub> = 5.0 V  
 V<sub>OUT</sub> = 2.5 V

$$\%DC = \frac{P_{D(MAX)}}{(V_{IN} - V_{OUT}) \times I_{OUT} + (V_{IN} \times I_{GND})}$$

$$\%DC = \frac{267 \text{ mW}}{(5.0 \text{ V} - 2.5 \text{ V}) \times 150 \text{ mA} + (5.0 \text{ V} \times 1.1 \text{ } \mu\text{A})}$$

$$\%DC = 71.2\%$$

P<sub>D(MAX)</sub> is assumed to be 267 mW.

For a 150 mA output current and a 2.5 V drop across the AAT3221/3222 at an ambient temperature of 85 °C, the maximum on-time duty cycle for the device is 71.2%.

The following family of curves shows the safe operating area for duty-cycled operation from ambient room temperature to the maximum operating level.

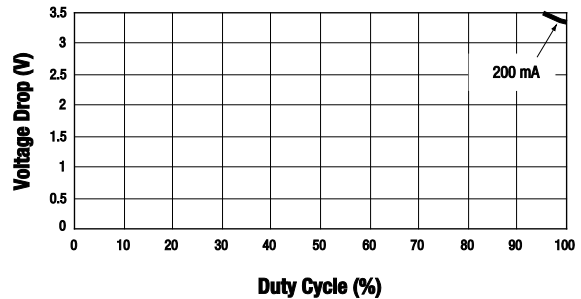

Figure 24: Device Duty Cycle vs Voltage Drop (V<sub>OUT</sub> = 2.5 V @ 25 °C)

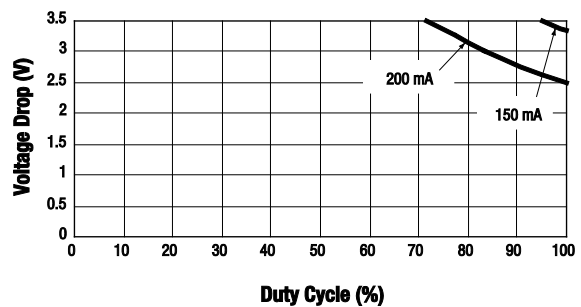

Figure 25: Device Duty Cycle vs Voltage Drop (V<sub>OUT</sub> = 2.5 V @ 50 °C)

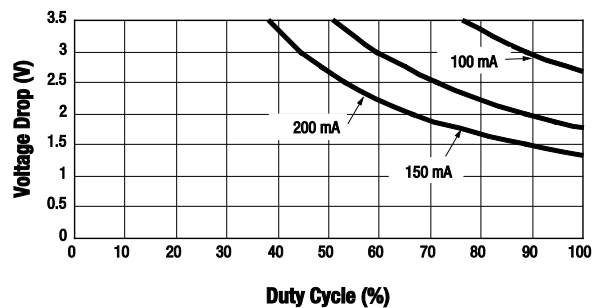

Figure 26: Device Duty Cycle vs Voltage Drop (V<sub>OUT</sub> = 2.5 V @ 85 °C)

### High Peak Output Current Applications

Some applications require the LDO regulator to operate at continuous nominal levels with short duration, high-current peaks. The duty cycles for both output current levels must be taken into account. To do so, one would first need to calculate the power dissipation at the nominal continuous level, then factor in the additional power dissipation due to the short duration, high-current peaks.

For example, a 2.5 V system using an AAT3221/2IGV-2.5-T1 operates at a continuous 100 mA load current level and has short 150 mA current peaks. The current peak occurs for 378 μs out of a 4.61 ms period. It will be assumed the input voltage is 5.0 V.

First, the current duty cycle percentage must be calculated:

$$\% \text{ Peak duty cycle} = x/100 = 378 \mu\text{s}/4.61 \text{ ms}$$

$$\% \text{ Peak duty cycle} = 8.2\%$$

The LDO regulator is under the 100 mA load for 91.8% of the 4.61 ms period and have 150 mA peaks occurring for 8.2% of the time. Next, the continuous nominal power dissipation for the 100 mA load should be determined then multiplied by the duty cycle to conclude the actual power dissipation over time.

$$P_D(\text{MAX}) = (V_{\text{IN}} - V_{\text{OUT}}) I_{\text{OUT}} + (V_{\text{IN}} \times I_{\text{GND}})$$

$$P_D(100\text{mA}) = (5.0 \text{ V} - 2.5 \text{ V}) \times 100 \text{ mA} + (5.0 \text{ V} \times 1.1 \mu\text{A})$$

$$P_D(100\text{mA}) = 250 \text{ mW}$$

$$P_D(91.8\% \text{D/C}) = \% \text{DC} \cdot P_D(100\text{mA})$$

$$P_D(91.8\% \text{D/C}) = 0.918 \times 250 \text{ mW}$$

$$P_D(91.8\% \text{D/C}) = 229.5 \text{ mW}$$

The power dissipation for a 100 mA load occurring for 91.8% of the duty cycle is 229.5 mW. Now, the power dissipation for the remaining 8.2% of the duty cycle at the 150 mA load can be calculated:

$$P_D(\text{MAX}) = (V_{\text{IN}} - V_{\text{OUT}}) I_{\text{OUT}} + (V_{\text{IN}} \times I_{\text{GND}})$$

$$P_D(150\text{mA}) = (5.0 \text{ V} - 2.5 \text{ V}) \times 150 \text{ mA} + (5.0 \text{ V} \times 1.1 \mu\text{A})$$

$$P_D(150\text{mA}) = 375 \text{ mW}$$

$$P_D(8.2\% \text{D/C}) = \% \text{DC} \times P_D(150\text{mA})$$

$$P_D(8.2\% \text{D/C}) = 0.082 \times 375 \text{ mW}$$

$$P_D(8.2\% \text{D/C}) = 30.75 \text{ mW}$$

The power dissipation for a 150 mA load occurring for 8.2% of the duty cycle will be 30.75 mW. Finally, the two power dissipation levels can be summed to determine the total true power dissipation under the varied load:

$$P_D(\text{total}) = P_D(100 \text{ mA}) + P_D(150 \text{ mA})$$

$$P_D(\text{total}) = 229.5 \text{ mW} + 30.75 \text{ mW}$$

$$P_D(\text{total}) = 260.25 \text{ mW}$$

The maximum power dissipation for the AAT3221/3222 operating at an ambient temperature of 85 °C is 267 mW. The device in this example has a total power dissipation of 260.25 mW. This is within the thermal limits for safe operation of the device.

## Printed Circuit Board Layout Recommendations

To obtain the maximum performance from the AAT3221/3222 LDO regulator, very careful attention must be considered in regard to the printed circuit board layout. If grounding connections are not properly made, power supply ripple rejection and LDO regulator transient response can be compromised.

The LDO regulator external capacitors C<sub>IN</sub> and C<sub>OUT</sub> should be connected as directly as possible to the ground pin of the LDO regulator. For maximum performance with the AAT3221/3222, the ground pin connection should then be made directly back to the ground or common of the source power supply. If a direct ground return path is not possible due to printed circuit board layout limitations, the LDO ground pin should then be connected to the common ground plane in the application layout.

## Evaluation Board Description

The AAT3221 Evaluation Board schematic diagrams are provided in Figures 27 and 28. The PCB layout is illustrated in Figures 29 and 30. Component values for the AAT3221 Evaluation Boards are listed in Tables 5 and 6.

## Package Information

Package dimensions are shown in Figures 31 (SOT23-5) and 33 (SC70JW-8), and tape and reel dimensions are provided in Figures 32 (SOT23-5) and 34 (SC70JW-8).

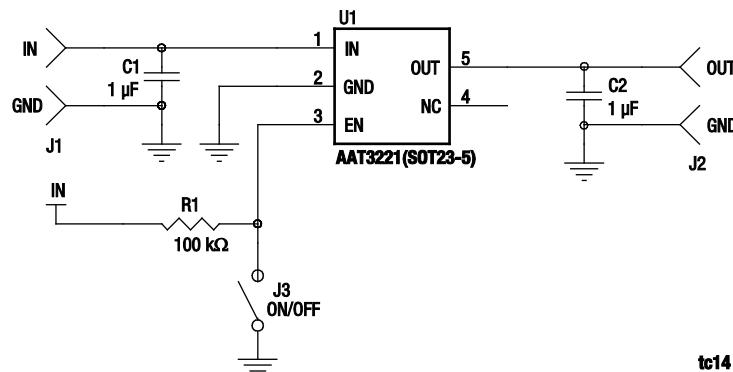

Figure 27: AAT3221 (SOT23-5) Evaluation Board Schematic

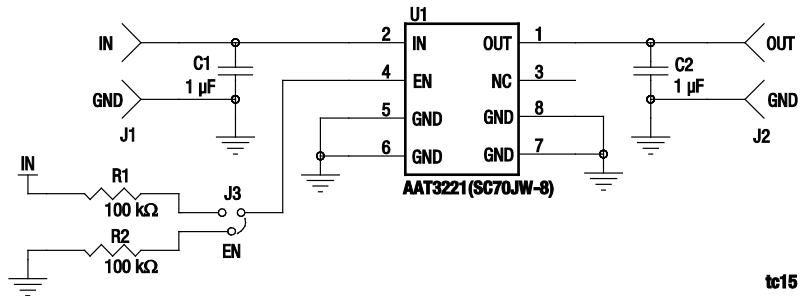

Figure 28: AAT3221 (SC70JW-8) Evaluation Board Schematic

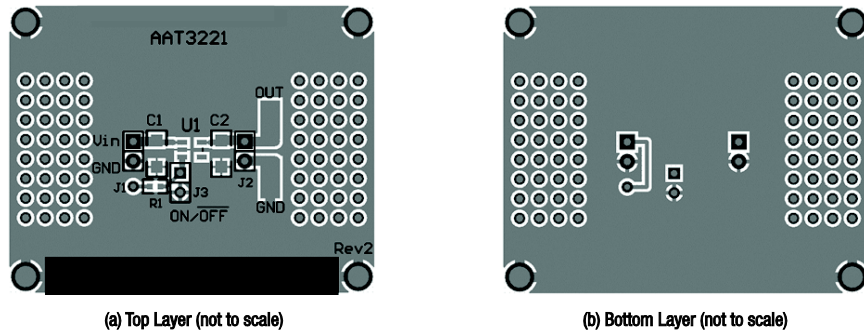

Figure 29: AAT3221 (SOT23-5) Evaluation Board

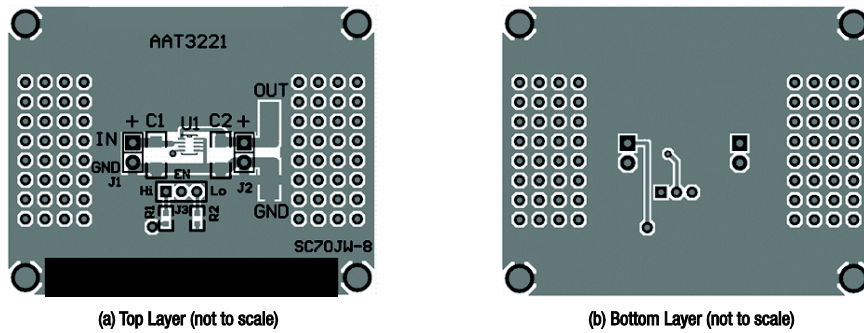

Figure 30: AAT3221 (SC70JW-8) Evaluation Board

Table 5. AAT3221 (SOT23-5) Evaluation Board Bill of Materials (BOM)

Component	Part Number	Description	Manufacturer
U1	AAT3221IGV-XX-T1	150 mA, NanoPower low dropout linear regulator	Skyworks
R1	RC0603FR-07100KL	Resistor, 100 kΩ, 1/10W, 1%, 0603 SMD	Yageo
C1, C2	GRM31MR71E105K	Cap Ceramic, 1 μF, 1206 X7R, 25V, 10%	Murata

Table 6. AAT3221 (SC70JW-8) Evaluation Board Bill of Materials (BOM)

Component	Part Number	Description	Manufacturer
U1	AAT3221IJS-XX-T1	150 mA, NanoPower low dropout linear regulator	Skyworks
R1,R2	RC0603FR-07100KL	Resistor, 100 kΩ, 1/10W, 1%, 0603 SMD	Yageo
C1,C2	GRM31MR71E105K	Cap Ceramic, 1 μF, 1206 X7R, 25V, 10%	Murata

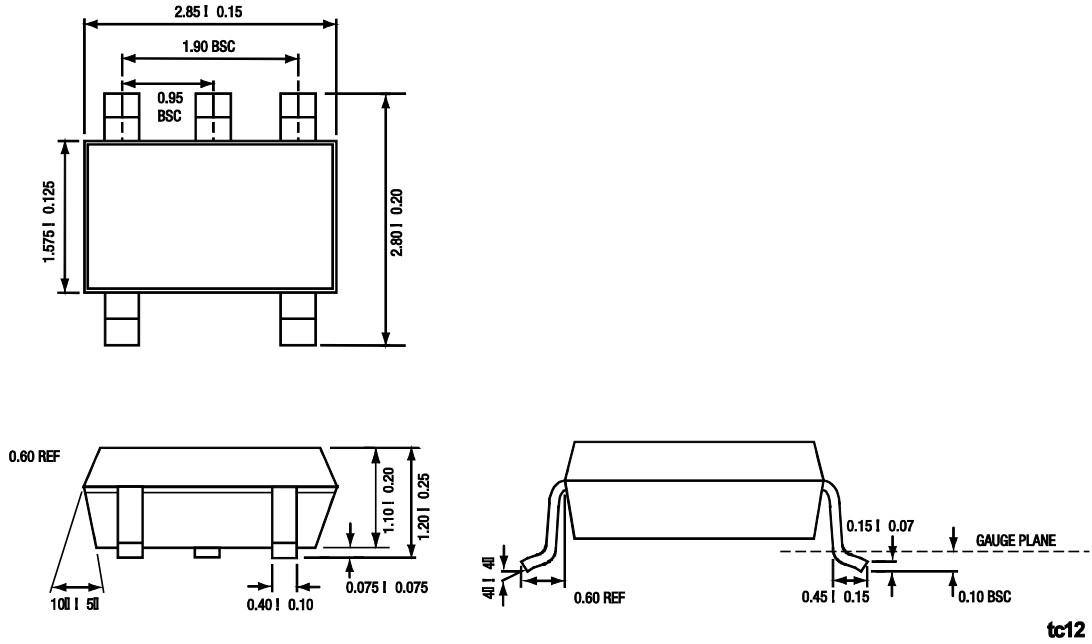
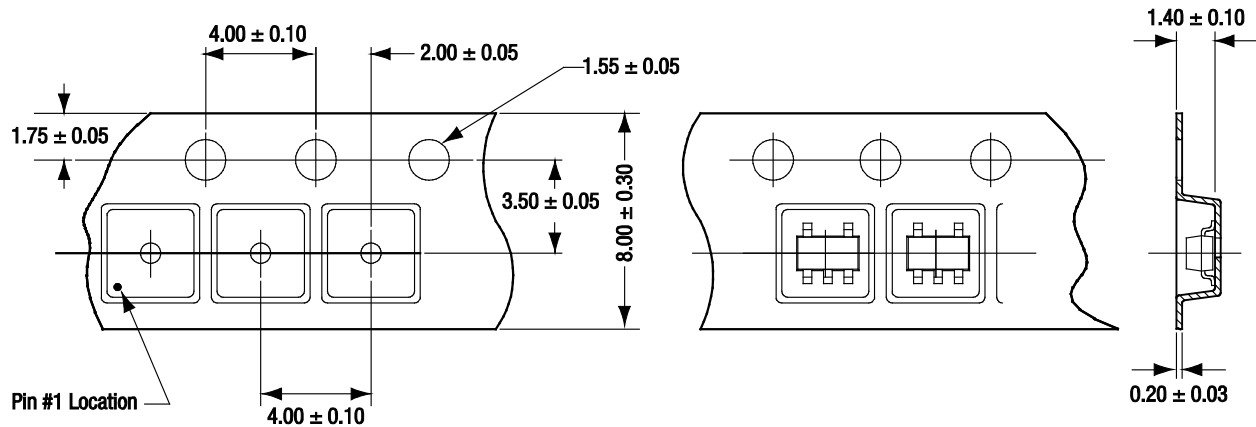

Figure 31. AAT3221/3222 5-Pin SOT23-5 Package Dimensions



All dimensions are in millimeters.

Figure 32. AAT3221/3222 Tape and Reel Dimensions (SOT23-5)

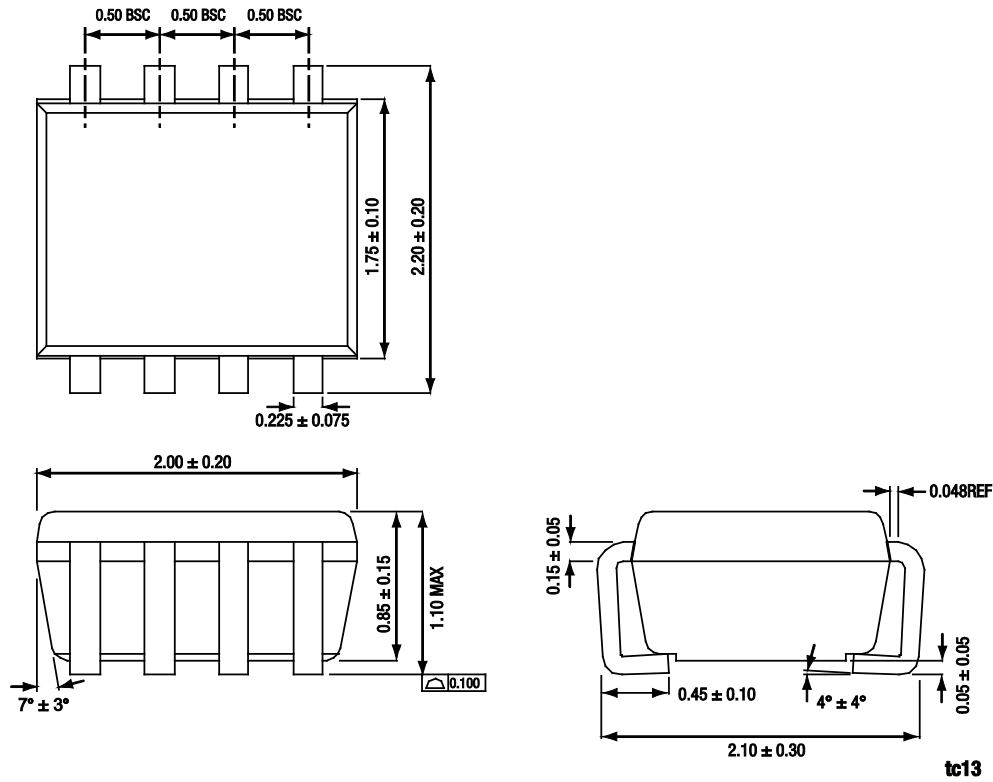
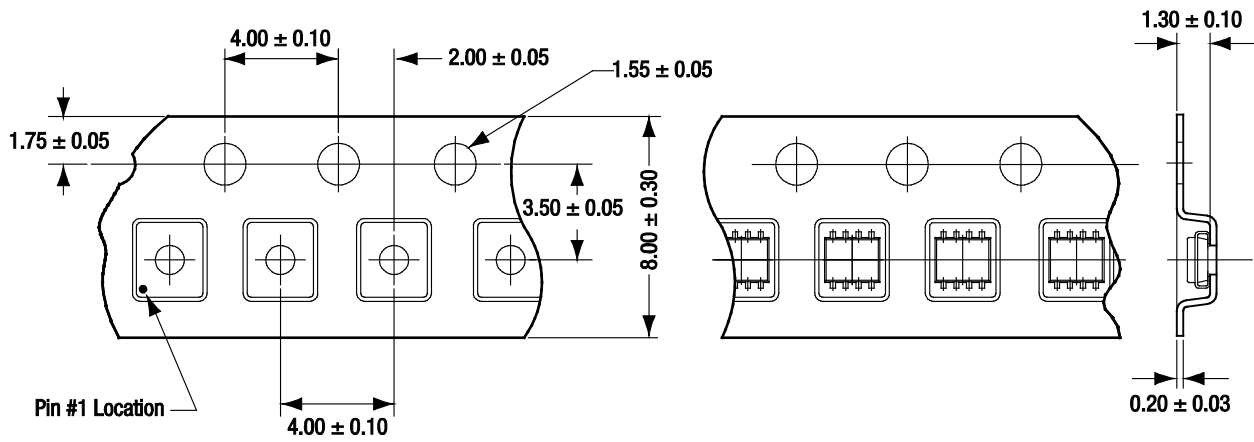

Figure 33. AAT3221 8-Pin SC70JW-8 Package Dimensions



All dimensions are in millimeters.

S3484

Figure 34. AAT3221/3222 Tape and Reel Dimensions (SC70JW-8)



**Ordering Information**

Output Voltage	Enable	Package	Marking (Note 1)	Part Number (Tape and Reel) (Note 2)		
1.6V	Active high	SOT23-5	GYXY	AAT3221IGV-1.6-T1		
1.7V			GBXY	<b>AAT3221IGV-1.7-T1</b>		
1.8V			BBXY	<b>AAT3221IGV-1.8-T1</b>		
1.9V			CGXY	<b>AAT3221IGV-1.9-T1</b>		
2.0V			BLXY	<b>AAT3221IGV-2.0-T1</b>		
2.3V			FLXY	<b>AAT3221IGV-2.3-T1</b>		
2.4V			FMXY	<b>AAT3221IGV-2.4-T1</b>		
2.5V			AKXY	<b>AAT3221IGV-2.5-T1</b>		
2.6V			GPXY	<b>AAT3221IGV-2.6-T1</b>		
2.7V			GDXY	<b>AAT3221IGV-2.7-T1</b>		
2.8V			AQXY	<b>AAT3221IGV-2.8-T1</b>		
2.85V			BYXY	<b>AAT3221IGV-2.85-T1</b>		
2.9V			JCXY	<b>AAT3221IGV-2.9-T1</b>		
3.0V			ALXY	<b>AAT3221IGV-3.0-T1</b>		
3.1V			GVXY	<b>AAT3221IGV-3.1-T1</b>		
3.3V			AMXY	<b>AAT3221IGV-3.3-T1</b>		
1.5V			Active high	SC70JW-8	CFXY	<b>AAT3221IJS-1.5-T1</b>
1.6V						AAT3221IJS-1.6-T1
1.7V						AAT3221IJS-1.7-T1
1.8V					BBXY	<b>AAT3221IJS-1.8-T1</b>
1.9V					CGXY	<b>AAT3221IJS-1.9-T1</b>
2.0V	BLXY	<b>AAT3221IJS-2.0-T1</b>				
2.3V	FLXY	<b>AAT3221IJS-2.3-T1</b>				
2.4V	FMXY	<b>AAT3221IJS-2.4-T1</b>				
2.5V	AKXY	<b>AAT3221IJS-2.5-T1</b>				
2.6V	GPXY	<b>AAT3221IJS-2.6-T1</b>				
2.7V	GDXY	<b>AAT3221IJS-2.7-T1</b>				
2.8V	AQXY	<b>AAT3221IJS-2.8-T1</b>				
2.85V	BYXY	<b>AAT3221IJS-2.85-T1</b>				
2.9V	JCXY	<b>AAT3221IJS-2.9-T1</b>				
3.0V	ALXY	<b>AAT3221IJS-3.0-T1</b>				
3.1V	GVXY	<b>AAT3221IJS-3.1-T1</b>				
3.2V	LEXY	<b>AAT3221IJS-3.2-T1</b>				
3.3V	AMXY	<b>AAT3221IJS-3.3-T1</b>				
3.5V	BMXY	<b>AAT3221IJS-3.5-T1</b>				
2.8V	Active low	SOT23-5			BIXY	<b>AAT3222IGV-2.8-T1</b>
2.9V						AAT3222IGV-2.9-T1
2.8V			CXY	<b>AAT3221IGV-2.8-2 T1</b>		

**Note 1:** XYY = assembly and date code.

**Note 2:** Sample stock is generally held on part numbers listed in **BOLD**.

Copyright © 2013 Skyworks Solutions, Inc. All Rights Reserved.

Information in this document is provided in connection with Skyworks Solutions, Inc. ("Skyworks") products or services. These materials, including the information contained herein, are provided by Skyworks as a service to its customers and may be used for informational purposes only by the customer. Skyworks assumes no responsibility for errors or omissions in these materials or the information contained herein. Skyworks may change its documentation, products, services, specifications or product descriptions at any time, without notice. Skyworks makes no commitment to update the materials or information and shall have no responsibility whatsoever for conflicts, incompatibilities, or other difficulties arising from any future changes.

No license, whether express, implied, by estoppel or otherwise, is granted to any intellectual property rights by this document. Skyworks assumes no liability for any materials, products or information provided hereunder, including the sale, distribution, reproduction or use of Skyworks products, information or materials, except as may be provided in Skyworks Terms and Conditions of Sale.

THE MATERIALS, PRODUCTS AND INFORMATION ARE PROVIDED "AS IS" WITHOUT WARRANTY OF ANY KIND, WHETHER EXPRESS, IMPLIED, STATUTORY, OR OTHERWISE, INCLUDING FITNESS FOR A PARTICULAR PURPOSE OR USE, MERCHANTABILITY, PERFORMANCE, QUALITY OR NON-INFRINGEMENT OF ANY INTELLECTUAL PROPERTY RIGHT; ALL SUCH WARRANTIES ARE HEREBY EXPRESSLY DISCLAIMED. SKYWORKS DOES NOT WARRANT THE ACCURACY OR COMPLETENESS OF THE INFORMATION, TEXT, GRAPHICS OR OTHER ITEMS CONTAINED WITHIN THESE MATERIALS. SKYWORKS SHALL NOT BE LIABLE FOR ANY DAMAGES, INCLUDING BUT NOT LIMITED TO ANY SPECIAL, INDIRECT, INCIDENTAL, STATUTORY, OR CONSEQUENTIAL DAMAGES, INCLUDING WITHOUT LIMITATION, LOST REVENUES OR LOST PROFITS THAT MAY RESULT FROM THE USE OF THE MATERIALS OR INFORMATION, WHETHER OR NOT THE RECIPIENT OF MATERIALS HAS BEEN ADVISED OF THE POSSIBILITY OF SUCH DAMAGE.

Skyworks products are not intended for use in medical, lifesaving or life-sustaining applications, or other equipment in which the failure of the Skyworks products could lead to personal injury, death, physical or environmental damage. Skyworks customers using or selling Skyworks products for use in such applications do so at their own risk and agree to fully indemnify Skyworks for any damages resulting from such improper use or sale.

Customers are responsible for their products and applications using Skyworks products, which may deviate from published specifications as a result of design defects, errors, or operation of products outside of published parameters or design specifications. Customers should include design and operating safeguards to minimize these and other risks. Skyworks assumes no liability for applications assistance, customer product design, or damage to any equipment resulting from the use of Skyworks products outside of stated published specifications or parameters.

Skyworks, the Skyworks symbol, and "Breakthrough Simplicity" are trademarks or registered trademarks of Skyworks Solutions, Inc., in the United States and other countries. Third-party brands and names are for identification purposes only, and are the property of their respective owners. Additional information, including relevant terms and conditions, posted at [www.skyworksinc.com](http://www.skyworksinc.com), are incorporated by reference.